

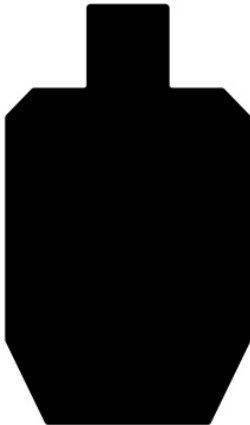









## Produktkatalog stålmål og tilbehør – PFT-avtale 2021-2024

Produktnummer	Produktnavn	Spesifikasjoner	Bilde
<b>PT Scout system</b>			
801-32510	PT Scout Stand Kit	<p>Includes:</p> <ul style="list-style-type: none"> <li>- (1) PT Scout target stand assembly</li> <li>· Left and right foot, base and top cap</li> <li>· Wing bolts and locking pins</li> <li>- Target plate is <b>not</b> included and should be selected à la carte</li> <li>- Wood beam not included (2"x4")</li> </ul>	
801-29185	PT Scout Target IPSC 100% (AR500)	<p>Features:</p> <ul style="list-style-type: none"> <li>- 3/8" AR500 steel</li> <li>- Smooth surface - no bolts, hooks or brackets</li> <li>- Multiple shapes and designs</li> <li>- Factory painted target plate</li> <li>- Zinc plated bracket to prevent corrosion and rust</li> <li>- Recommended for pistol calibers from 10 yards and beyond</li> </ul>	



801-29179	PT Scout Target Circle - 6" (AR500)	<p>Features:</p> <ul style="list-style-type: none"> <li>- 3/8" AR500 steel</li> <li>- Smooth surface - no bolts, hooks or brackets</li> <li>- Multiple shapes and designs</li> <li>- Factory painted target plate</li> <li>- Zinc plated bracket to prevent corrosion and rust</li> <li>- Recommended for pistol calibers from 10 yards and beyond</li> </ul>	 
801-29177	PT Scout Target Circle - 8" (AR500)		
801-29175	PT Scout Target Circle - 10" (AR500)		
801-29173	PT Scout Target Circle - 12" (AR500)		
801-29189	PT Scout Target IPSC - B/C Zone (AR500)	<p>Features:</p> <ul style="list-style-type: none"> <li>- 3/8" AR500 steel</li> <li>- Smooth surface - no bolts, hooks or brackets</li> <li>- Multiple shapes and designs</li> <li>- Factory painted target plate</li> <li>- Zinc plated bracket to prevent corrosion and rust</li> <li>- Recommended for pistol calibers from 10 yards and beyond</li> </ul>	
801-29183	PT Scout Target IDPA -1 Zone (AR500)	<p>Features:</p> <ul style="list-style-type: none"> <li>- 3/8" AR500 steel</li> <li>- Smooth surface - no bolts, hooks or brackets</li> <li>- Multiple shapes and designs</li> <li>- Factory painted target plate</li> </ul>	

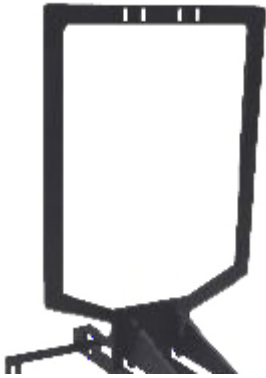

		<ul style="list-style-type: none"> <li>- Zinc plated bracket to prevent corrosion and rust</li> <li>- Recommended for pistol calibers from 10 yards and beyond</li> </ul>	
801-29181	PT Scout Target Rectangle - 18" X 24" (AR500)	<p>Features:</p> <ul style="list-style-type: none"> <li>- 3/8" AR500 steel</li> <li>- Smooth surface - no bolts, hooks or brackets</li> <li>- Multiple shapes and designs</li> <li>- Factory painted target plate</li> <li>- Zinc plated bracket to prevent corrosion and rust</li> <li>- Recommended for pistol calibers from 10 yards and beyond</li> </ul>	
801-22743	PT Scout Top Cap	<p>Slide multiple top caps onto your 2x4 to add more target plates to your PT Scout. Hardware not included!</p>	
801-29171	PT Scout Target Base Shield (AR500)		

801-32197	PT Scout Base	Base replacement part for PT Scout. Handle and quick release pin not included.	
<b>Andre mål</b>			
AT-208-3-0	PT Hostage	<p>Specifications:</p> <ul style="list-style-type: none"> <li>- Weight: 57 lbs.</li> <li>- Height: 5' (with the recommended 3' stand)</li> <li>- Head plate: 13" x 24" torso</li> <li>- Reactive swinging head plate: 6" diameter</li> <li>- Steel grade: 3/8" AR550 armor steel</li> <li>- Handgun shooting distance: 10+ yards</li> <li>- Rifle shooting distance: 100+ yards using ammunition below 3,000 fps</li> </ul>	



<p>CT-100-H-02 KIT</p>	<p>Challenge Targets Extreme Reactive 8" Target System w/ Armored Front Plate</p>	<p>Reactive target falls back completely and resets itself using a patented counterbalance technology with no battery or pneumatic power required.</p> <ul style="list-style-type: none"> <li>- 8" diameter x 3/8" thick AR500 target plate installs in seconds and is reversible for extended life</li> <li>- Rated for handguns 9mm to .357 magnum (minimum distance 10 yards)</li> <li>- Rated for rifles 5.56mm to 7.62x39mm (minimum distance 100 yards)</li> <li>- Rated for rifles 7.62x51mm (minimum distance 300 yards)</li> <li>- Target system can be transported in (4) sections and set-up without tools</li> <li>- Total system weight is 112 lbs. (Heaviest section is 43 lbs.)</li> <li>- Kit includes 3/8" thick AR500 steel Front Armor Guard</li> <li>- Rocker mechanism and target base are powder coated black</li> <li>- Target height is 31" from the ground to the top of the 8" plate</li> <li>- Target plate and front armor guard ship unpainted</li> </ul>	
------------------------	---	--	---



STD#01	Base Multipurpose	<p>Denna ställning måste ingå i målsystem. Alla träffytor passar i denna ställning. Tillverkad i 10 mm 500 HB stål. Matt svart färg.</p>	
STD#04	Frame for gongs	<p>Inkluderat 2 st krokar Denna produkt behövs för att kunna använda hängande träffytor. (Gong). Tillverkad i 10 mm 500 HB stål. Matt svart färg.</p>	

TGT#04	Gong	Size 200 x 300 mm Tillverkad i 10 mm 500 HB stål. Matt svart färg.	
Eksempel: STD#01, STD#04 og TGT#04			

TGT#05	Gong IPSC	Size IPSC A-zon Tillverkad i 10 mm 500 HB stål. Matt svart färg.	
STD#04H	Spare hanging hooks	2 styck Tillverkad i 10 mm 500 HB stål. Matt svart färg.	



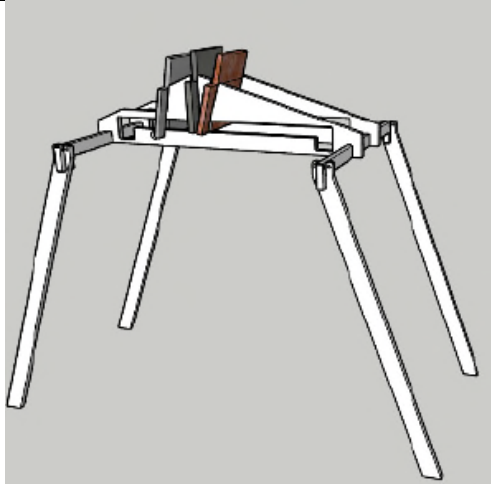

TGT#03	Torso_Head	<p>Tillverkad i 10 mm 500 HB stål. Matt svart färg. Vikt Ca 15 kg</p> <p>Mrk: Base Multipurpose (STD#01) inngår ikke.</p>	
TGT#01	Mini popper	<p>Tillverkad i 10 HB stål. Matt svart färg. Vikt ca 8 kg</p> <p>Mrk: Base Multipurpose (STD#01) inngår ikke.</p>	

<p>STD#03</p>	<p>Extension legs</p>	<p>4 st Tillbehör vis kunden vill ha mulighet att höja träffytan. Tillverkad i 10 mm 500 HB stål. Matt svart färg.</p>	
<p>STD#02</p>	<p>Tgt Stand &amp; bracket</p>	<p>Beupva Pam Til Fot och hållare. hövs för att hänga p träffyor med gnsbult. ssar trä-regel 45x70 m. verkad i mjukstål Matt svart färg. I</p>	

TGT#10	Full Size IDPA Target	<p>Inklusive 2 st vagnsbult + 2 st fjäder. Tillverkad i 10 mm 500 HB stål. Matt vit färg.</p> <p>Passer til STD#2</p>	
TGT#11	B-AC IDPA Target	<p>Inklusive 2 st vagnsbult + 2 st fjäder. Tillverkad i 10 mm 500 HB stål. Matt vit färg.</p> <p>Passer til STD#2</p>	

M1	MARIO SF	3D-dukke som kan utstyres med stålmål i hode og bryst (følger ikke med)	
----	----------	---	---

M2	MARIO HC	<p>MARIO dukke med stålplate i bryst.</p> <p>Leveres med:</p> <ul style="list-style-type: none"><li>- Stativ</li><li>- Overkropp med hode og armer</li><li>- Pistol</li><li>- Kniv</li></ul>	
----	----------	--	--

M5	MARIO sniper	MARIO dukke med stål-gong	
H3	HEAD TARGET	Hode som passer til MARIO-serien, med Hardox 500 stålplate i ansiktsområdet.	
M-03	BlinkTroll MKIII Main Unit	Beveglig mål for stålblink. Hovedenhet.  Diverse tilbehør på forespørsel.	

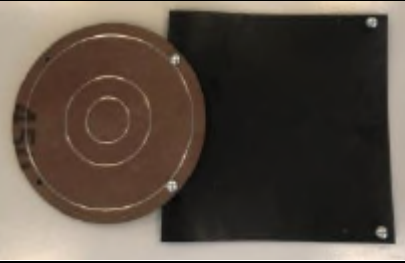
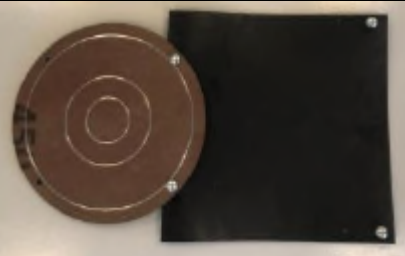
ACC-003	Ø350 mm HARDOX – STEEL TARGET	Ø350 mm HARDOX – STEEL TARGET for BlinkTroll	
ACC_004	Ø250 mm HARDOX – STEEL TARGET	Ø250 mm HARDOX – STEEL TARGET for BlinkTroll	

Obsima kan i tillegg skaffe hele Action Targets produktportefølje, samt andre statiske og bevegelige stålmål.

For priser og betingelser, kontakt:

[salg@obsima.no](mailto:salg@obsima.no)

tlf: 63 93 81 80

