



Raufoss ProRack

-for Defence and Police

Raufoss ProRack

Raufoss ProRack is a modular rack system for professional users, for example Defence forces and Police. It sets a new standard for high security and quick response time. The system is optimized for local storage of weapons in frequent (daily) use. It can be installed in strongrooms, armouries and large gun safes.

The weapon storage system has been developed in cooperation with the Norwegian Defence Logistics Organisation and is now being installed in military bases nationwide. It is designed for all types of personal soldier weapons, from pistols and assault rifles to heavy machine guns.

The modular design offers great flexibility. The system can easily be customized for local preferences. The user can at any time adjust the system for new applications and needs, for example new weapon types.

All Raufoss ProRack units are equipped with either an integrated code padlock for individual weapons, or a lock system for multiple weapons.

System characteristics:

- High security
- Quick access in emergency
- Space efficient
- Flexible and adaptable
- Instant overview of weapon status

Index

Component overview	Page 3	Trolley	Page 11
ProRack One	Page 4	Multi modules	Page 12
ProRack eBox	Page 5	LiteRack program	Page 14
ProRack pBox	Page 6	Armory program	Page 16
ProRack bBox	Page 7	Shelves and drawers	Page 19
ProRack Panel system	Page 8	Safety cabinets	Page 22
Panel wall	Page 9	Unloading stations	Page 26
Panel isles	Page 10	Accessories	Page 27

ProRack
bBox
Page 7

ProRack
One
Page 4

ProRack
pBox
Page 6

ProRack
Panel
Page 8

ProRack
eBox
Page 5

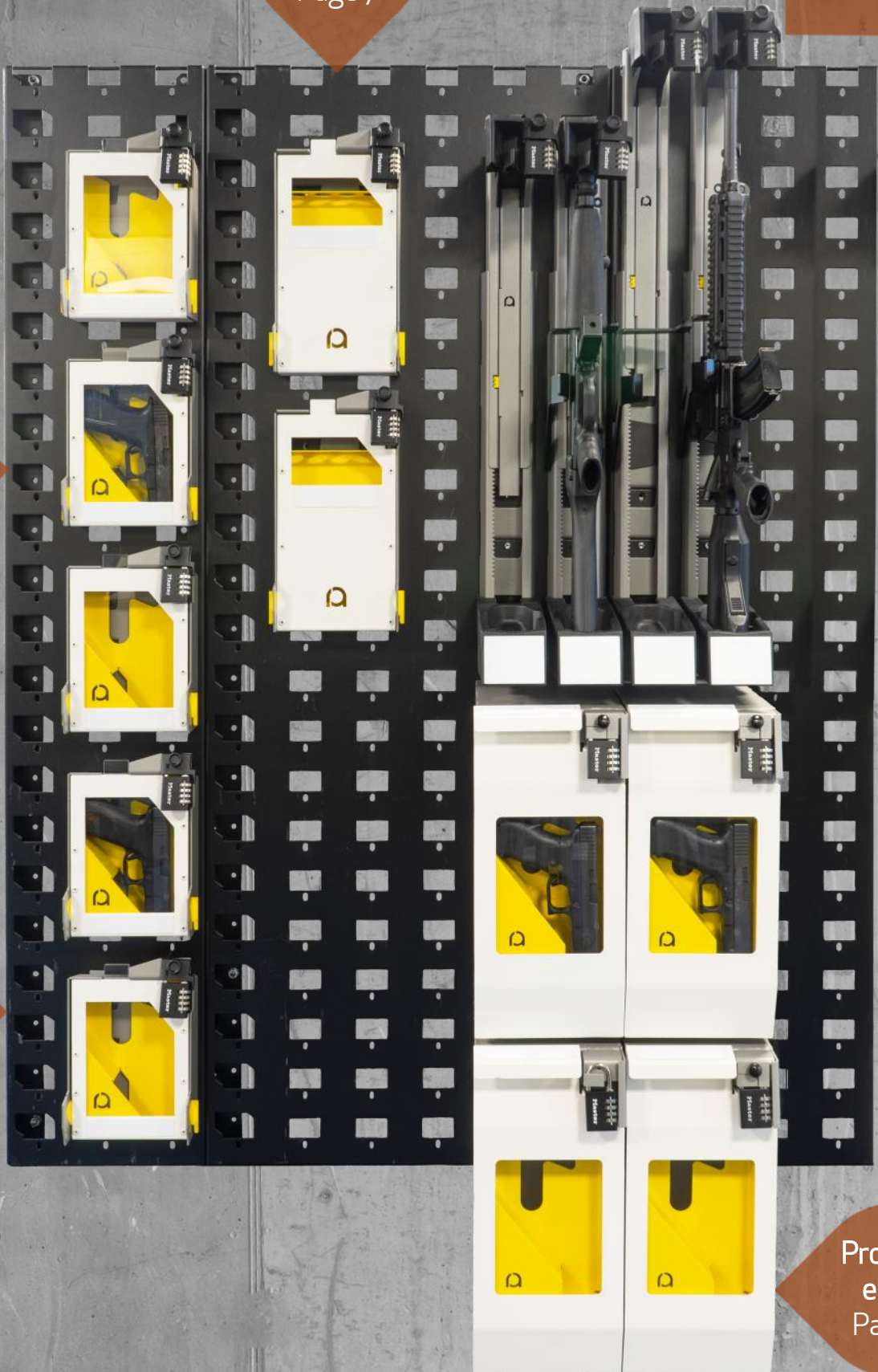

ProRack One

PART NUMBER: ProRack One: 803014
 ProRack One L: 803015
 ProRack One XL: 803016

- Telescopic weapon stand
- Can be used for all common assault rifles and machine pistols
- Easy length adjustment
- Intergrated code padlock



Open

Locked

Length adjustment

*Use ProRack L for weapons longer than 90 cm
 Use ProRack XL for weapons longer than 110 cm

Weapon type	Weapon stand length [cm]
G3, AG3*	108,0
HK417*	105,0
FN MINIMI*	91,7
HK416	87,8
HK416K	72,6
G3, AG3 retractable stock	87,0
MP5	75,1
MP5 retractable stock	57,4
MP7	57,2

ProRack eBox

PART NUMBER: 804023

- Equipment box for weapon accessories
- Integrated cassette for hand guns (optional)
- Large window for easy inspection
- Integrated code padlock
- Tilt box for easy access
- Tilt box can be lifted out



Other eBox interior can be provided on request



External dimensions [cm]

Height	43,5
Width	19,5
Depth	29,5

Internal dimensions [cm]

Height	40
Width	18
Depth	26,5



ProRack pBox

PART NUMBER: 803030

- For pistols
- Large window for easy inspection
- Integrated code padlock
- Easy access



External dimensions [cm]	
Height	27
Width	19
Depth	6

ProRack bBox

PART NUMBER: 811012

- Storage box for batons
- Large window for easy inspection
- Integrated code padlock
- Easy access
- Fits batons up to 28 mm in diameter

External dimensions [cm]	
Height	35
Width	19

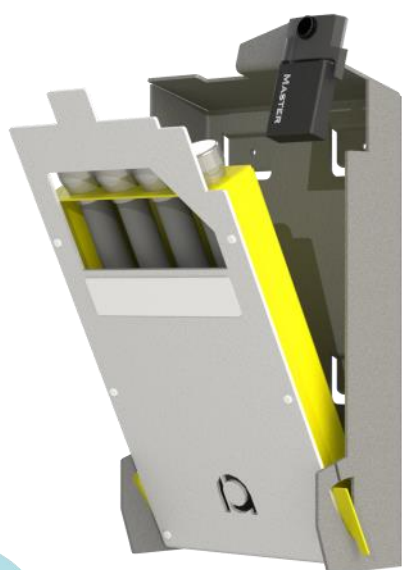

ProRack panel system

PART NUMBER: See table

The panel building system makes it easy to install Raufoss ProRack. Start with mounting the panels on the wall, using panels of different sizes to «build around» light switches, fire extinguishers and other obstacles. Thereafter attach the ProRack equipment (weapon stands, boxes, shelves etc) to the panels at the desired positions. The equipment can later be repositioned to suit new user needs.

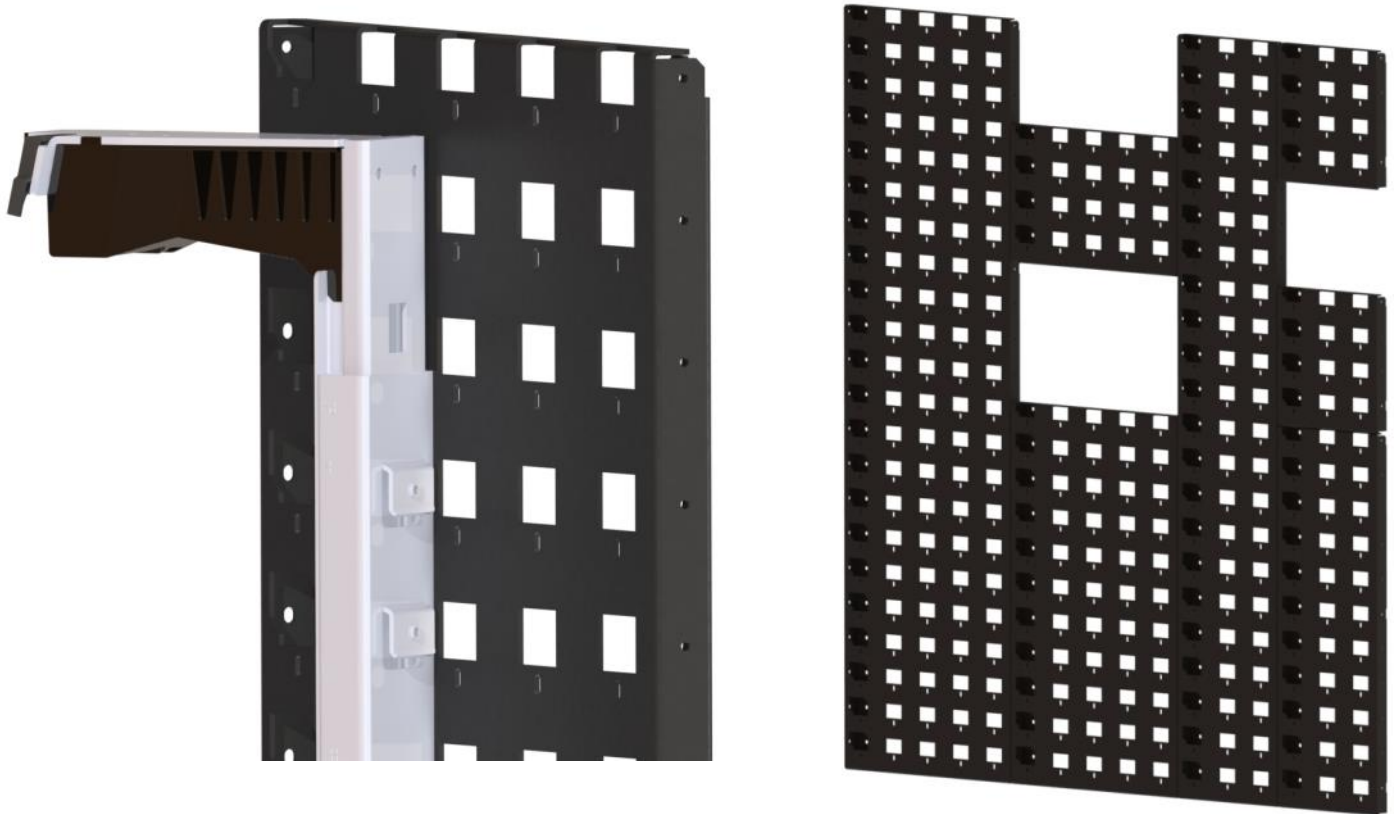

Robust fastening system

Panels and dimensions [cm]	Part number
Rack Panel H165 B60	800011
Rack Panel H165 B50	801011
Rack Panel H82 B50	801021
Rack Panel H30 B50	801031
Rack Panel H165 B30	802011
Rack Panel H82 B30	802021
Rack Panel H30 B30	802031

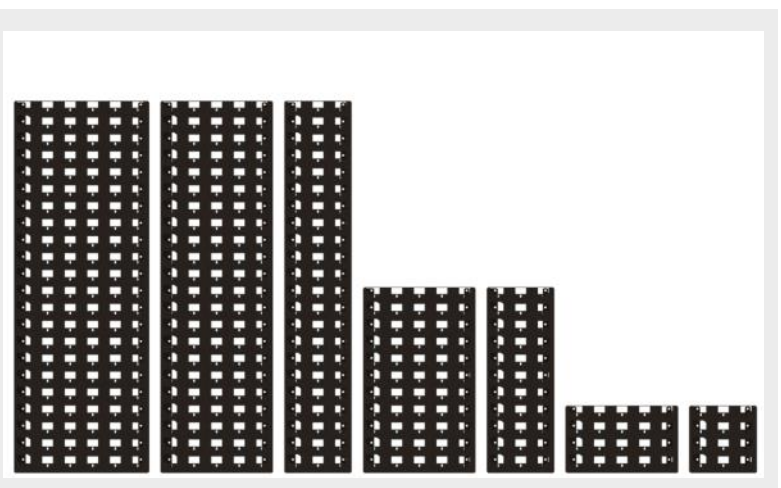

Panel wall

PART NUMBER: See table

- Free-standing wall
- For maximum utilization of floor area
- Panels on both sides
- Base length 1.0 m and 1.2 m
- Wall extension with 0.3 m and 0.5 m sections

Dimensions	Part number
Free-standing panel wall L = 100 cm	808010
Free-standing panel wall L = 120 cm	808012
End panel for extension of panel wall	808011



Panel isles

PART NUMBER: See table

- For utalization of floor area
- Four sided storage area
- Dimensions can be customized

Isle dimensions [cm]	Weapon capacity	Part number
30 x 30	24	808023
50 x 50	40	808022
60 x 60	48	808020
80 x 80	64	808021
50 x 80	52	808024



Trolley

PART NUMBER: See table

- Can be equipped with all ProRack product combinations
- Trolleys can be custom built on request

Version	Part number
Trolley frame version	808040
Trolley panel version	808030
Trolley with low panels	On request

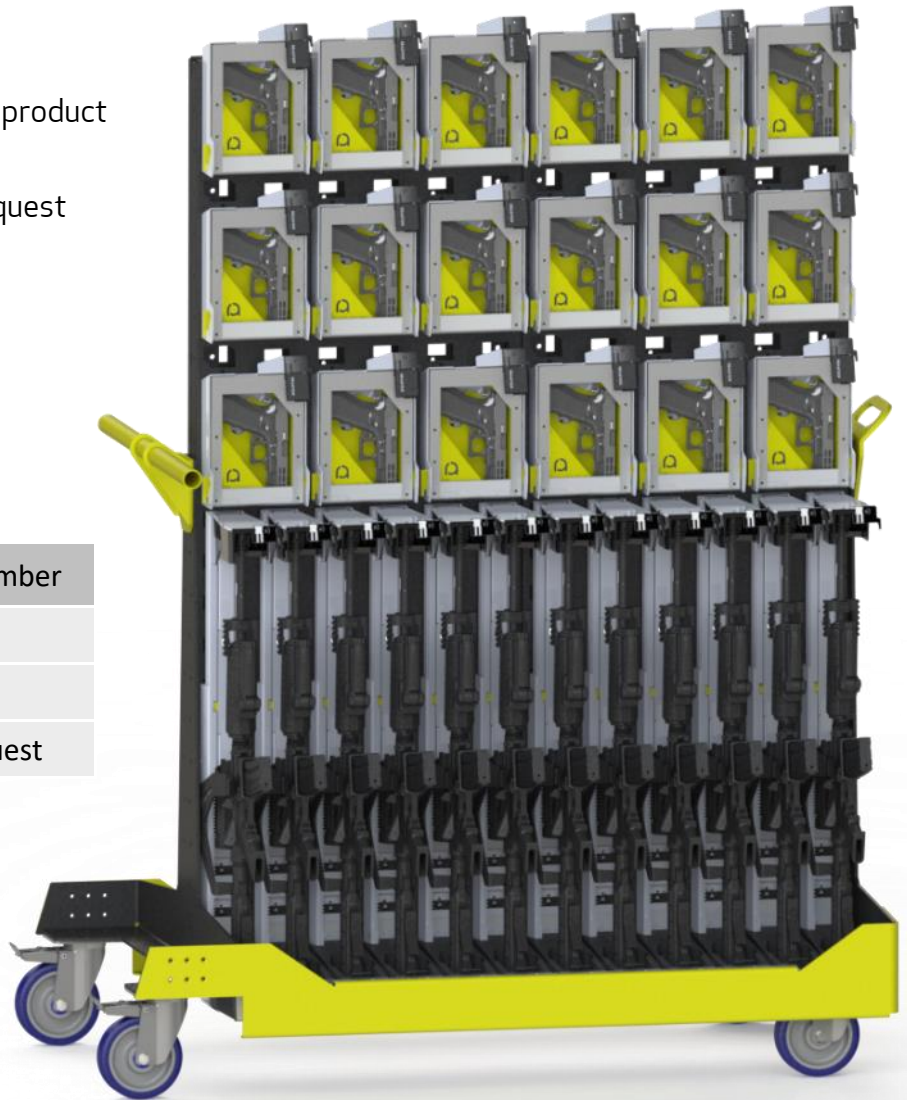

Trolley with pBoxes and ProRack One weapon stands

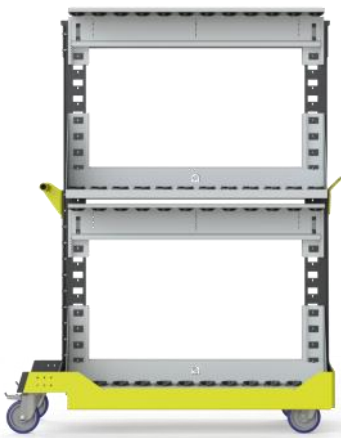

Trolley with 12-in-1 Module, with and without weapons

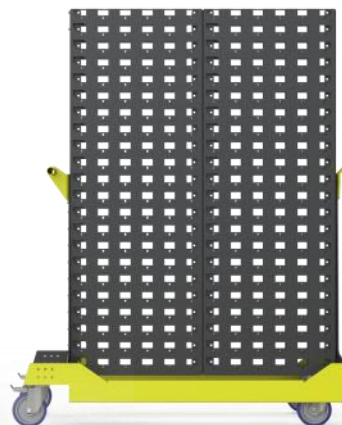
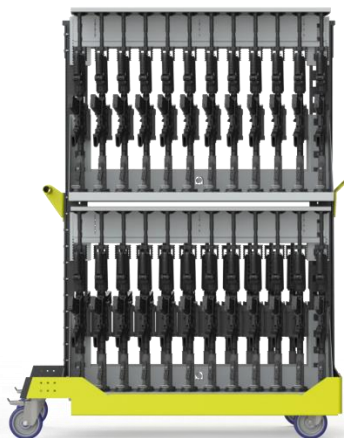

Trolley with panels

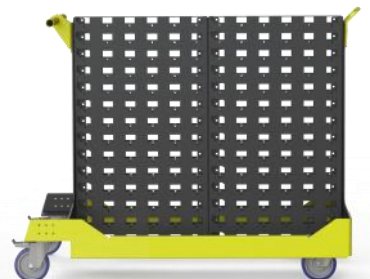

Trolley with low panels

Multi modules

Space efficient storage units for multiple weapons

10-in-1 Module

PART NUMBER: 803050

- For 10 weapons
- Easy length adjustment
- Overlapping feature maximize the number of weapons in height
- Lock all 10 weapons with the padlock provided
- Other weapon capacities are available on request

10-in-1 Overlap Module mounted on ProRack panels in two heights

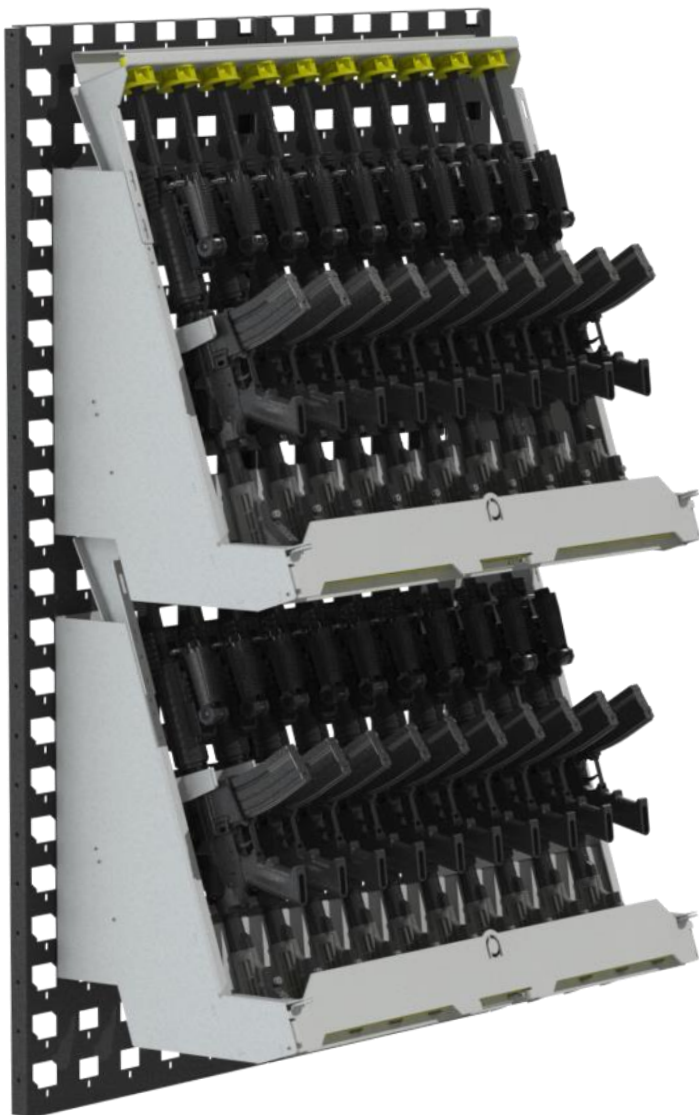

10-in-1 Module

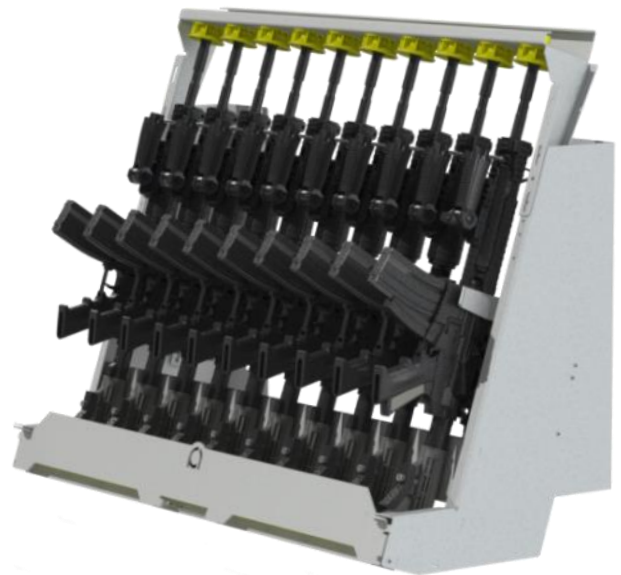

12-in-1 Module

PART NUMBER: 803070

- For use on wall and trolley
- The distance between upper and lower unit can be adjusted to fit different weapons.
- All 12 weapons can be locked with a WireLock

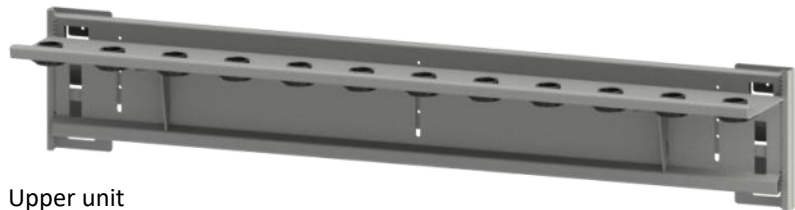

Upper unit



Lower unit

12-in-1 Module with weapons



12-in-1 Modules mounted on Trolley



LiteRack

The LiteRack product line consists of cost-efficient storage units and can be used where individual locking of each weapon is not needed.

Combine High and Low units from a wide product range to build optimized storage solutions.

The pictures below show examples of how LiteRack units can be combined to for storage of different weapons.

Solution for HMG barrel: Low 1 and Hole 1

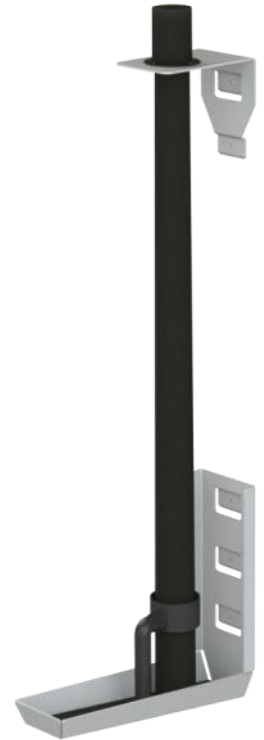

Combination of High 5 and Low 5

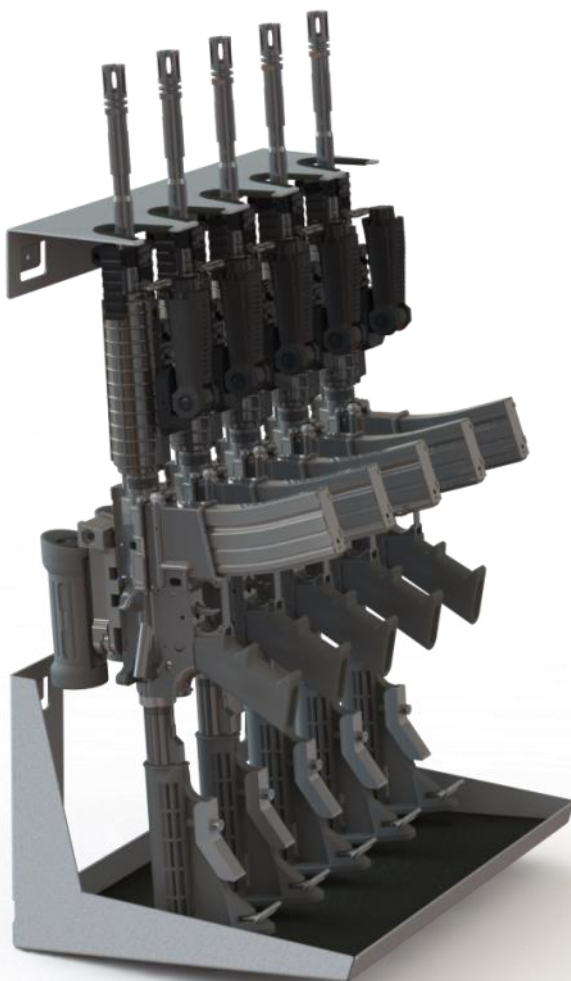

Combination of High 1 and Low 1



Combination of High wide and Low wide



High 1

PART NUMBER: 809045



Hole 1

PART NUMBER: 809088



High wide

PART NUMBER: 809015

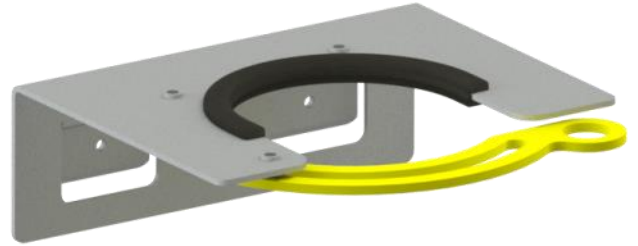

Low 1

PART NUMBER: 809075



Low wide

PART NUMBER: 809055



High 5

PART NUMBER: 809025



Low 5

PART NUMBER: 809065



HandGun 1

PART NUMBER: 809089



HandGun 5

PART NUMBER: 809090



Armory program

- The Armory program is designed for support weapons and heavy machine guns
- All Armory program units are designed for easy mounting on ProRack panels, and are well suited for mounting in safety cabinets
- Please contact us for advice on storage solutions

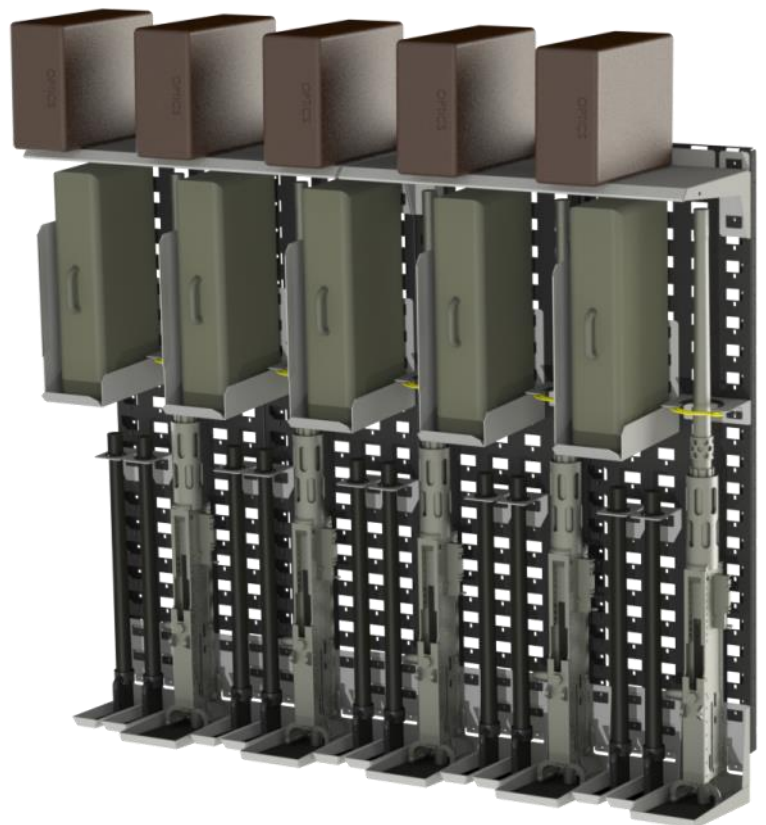

Horizontal 4

PART NUMBER: 803045

Sold in pairs

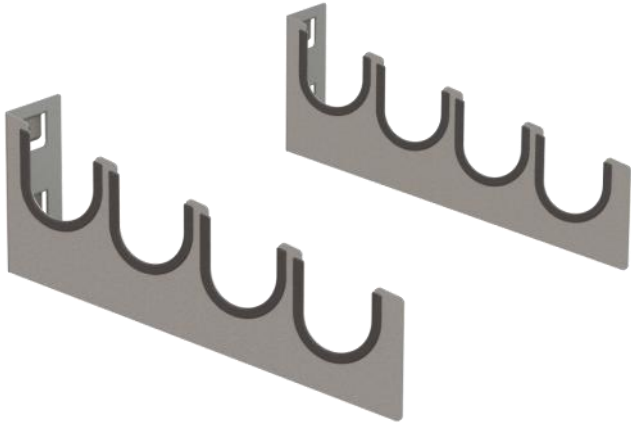

Horizontal 4 with machine guns



Barrel 8

PART NUMBER: 803046

Can also be used for support weapons and machine guns

Heavy machine gun (.50 cal) barrels



HMG Module

PART NUMBER: 803041

For heavy machine guns. The module consist of an upper and lower part, and is height adjustable.

Can be delivered for multiple weapons upon request

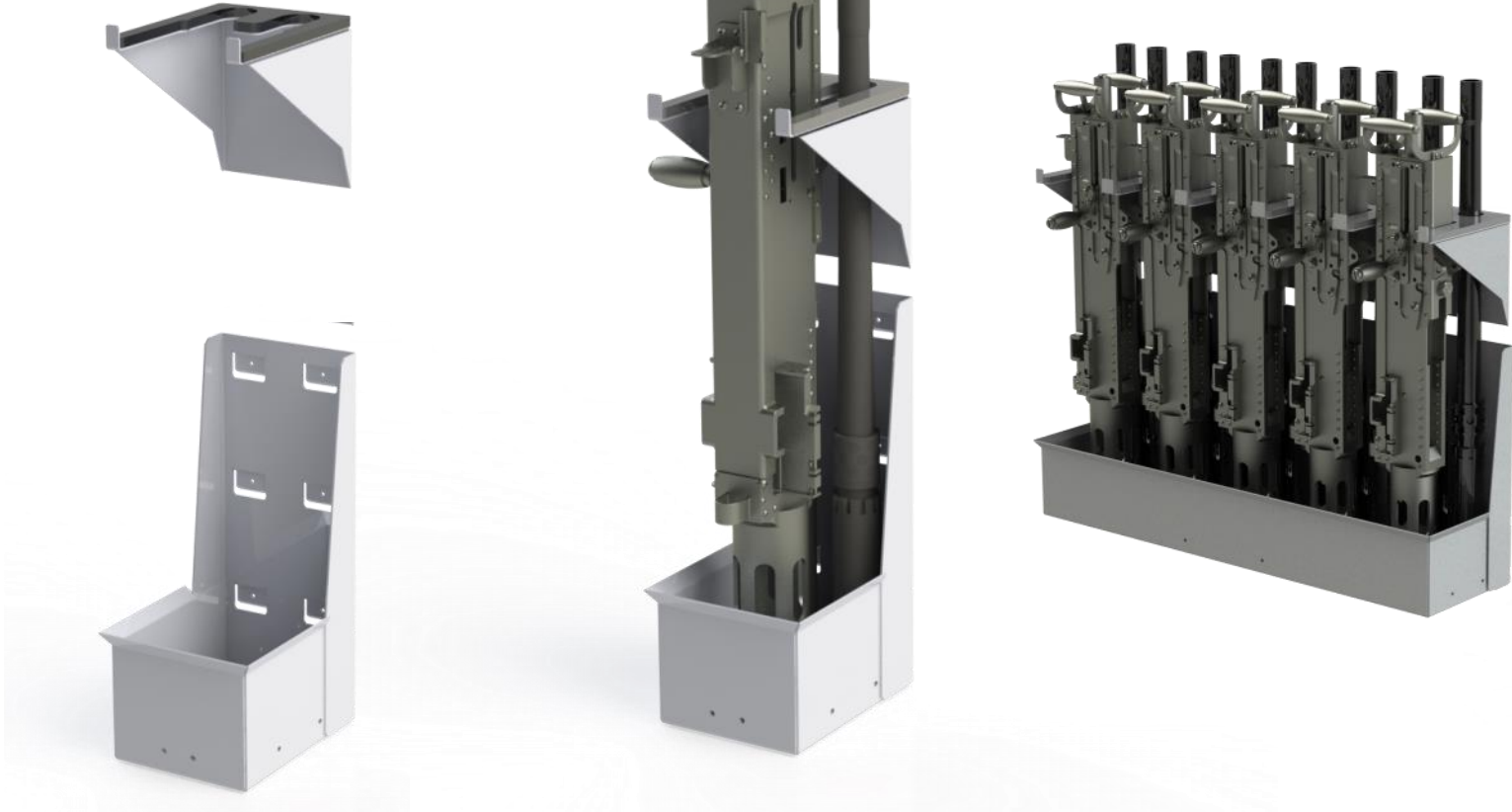

Barrel module

PART NUMBER: 803042

Consists of an upper and lower part, hight adjustable

Barrel module with heavy machine gun barrels

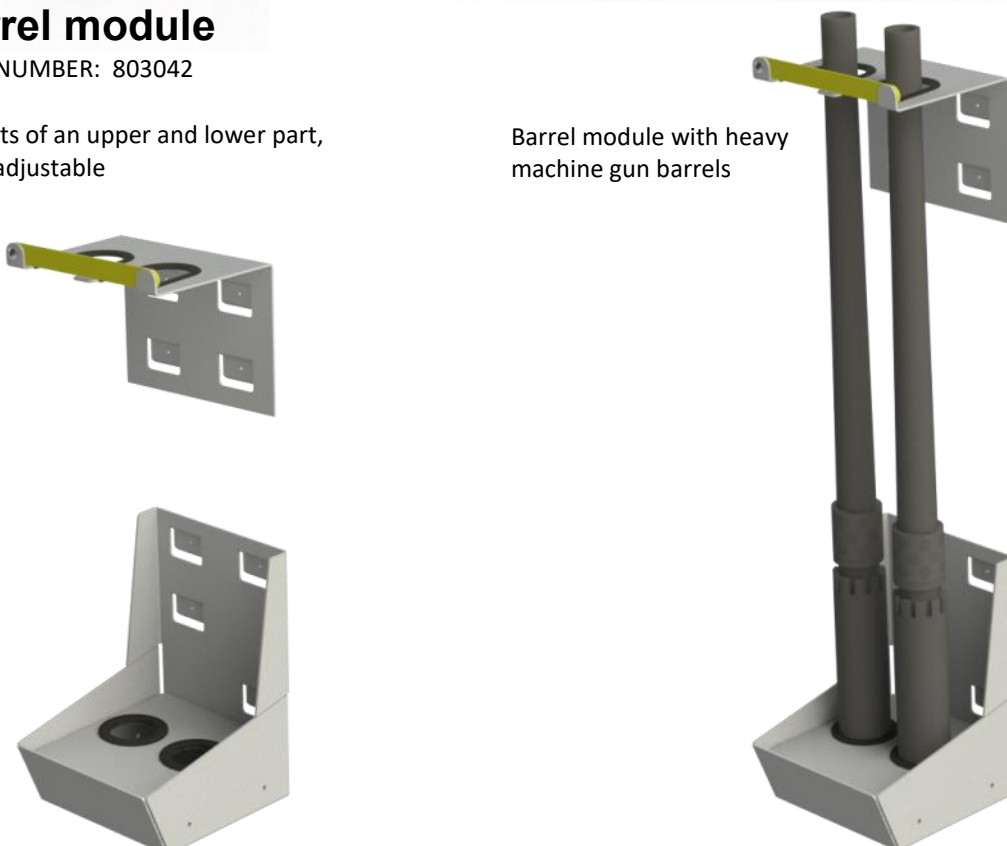

Shelves and drawers

- Shelves can be mounted on ProRack panels
- Strong shelves with self supporting construction and no legs
- Allows for easy storage of long items and equipment

Shelf 60

PART NUMBER: 807012

Depth: 60 cm length: 100 cm

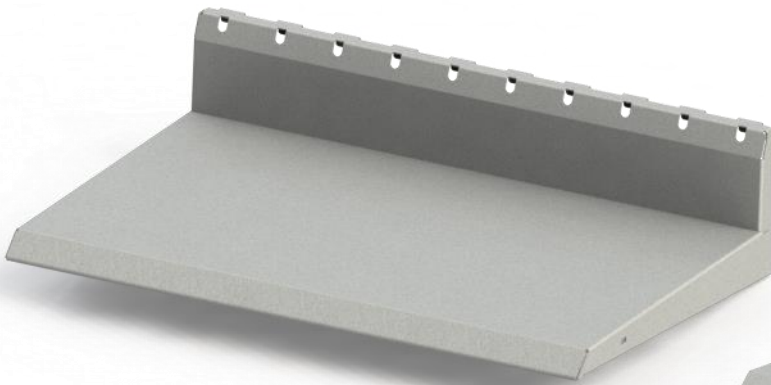

Shelf 40

PART NUMBER: 807013

Depth: 40 cm length: 100 cm

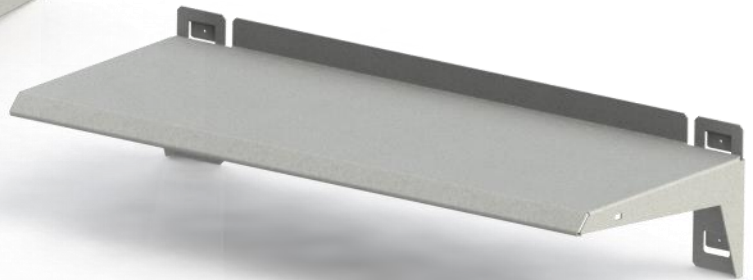

Picture shows Shelf 60 units installed

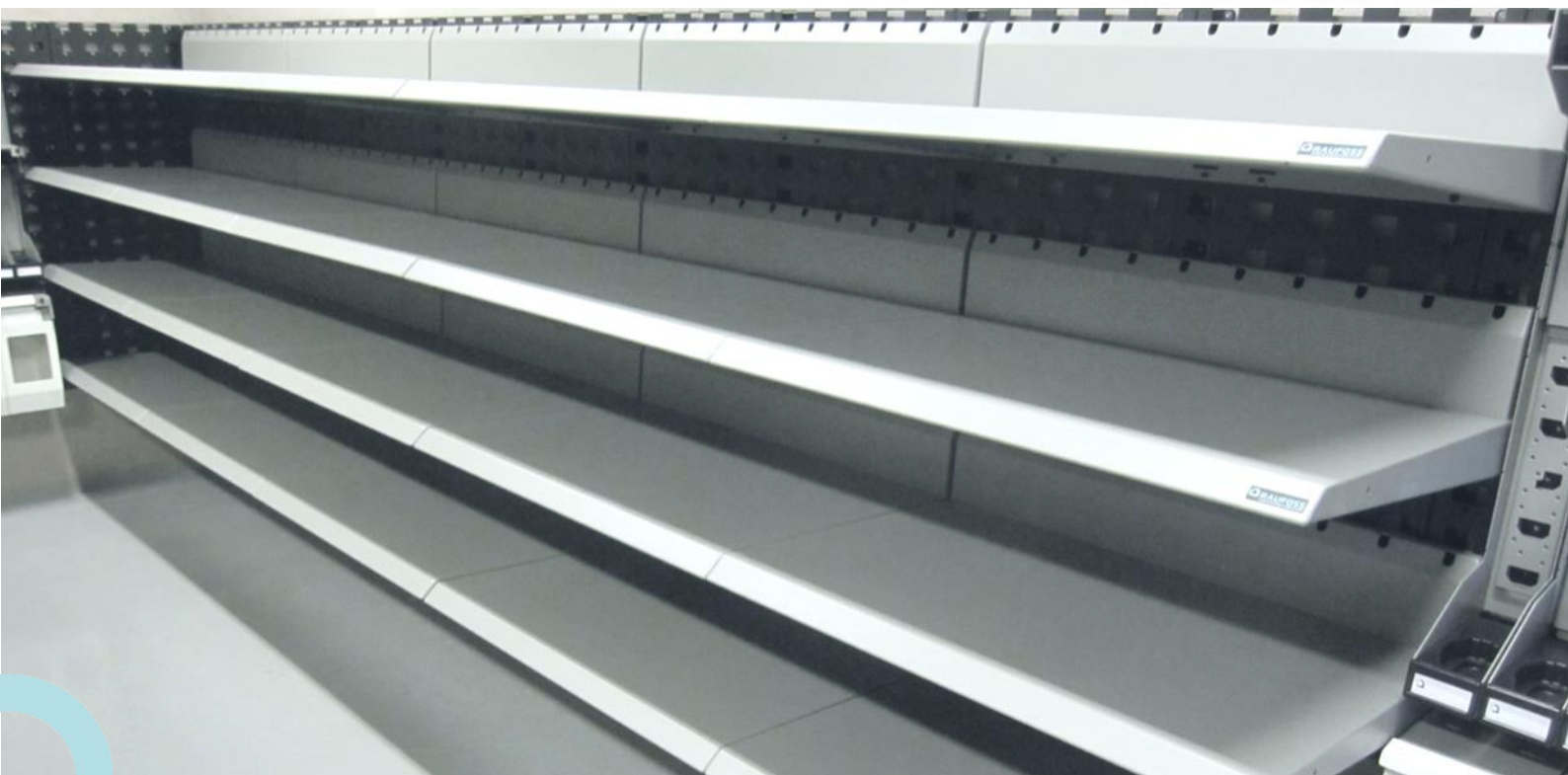

Bag shelf 20

PART NUMBER: 807026

Width: 19,5 cm Height: 50 cm Depth: 40 cm



Shelf bracket

PART NUMBER: 807025

Width: 19 cm Depth: 34 cm



Drawer 60

PART NUMBER: 807021

Width: 58 cm Height: 33,5 cm Depth: 50 cm

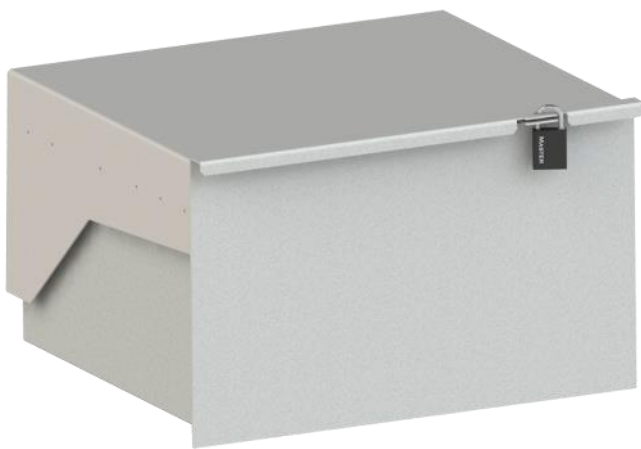

Drawer 30

PART NUMBER: 807022

Width: 28,5 cm Height: 26 cm Depth: 50 cm

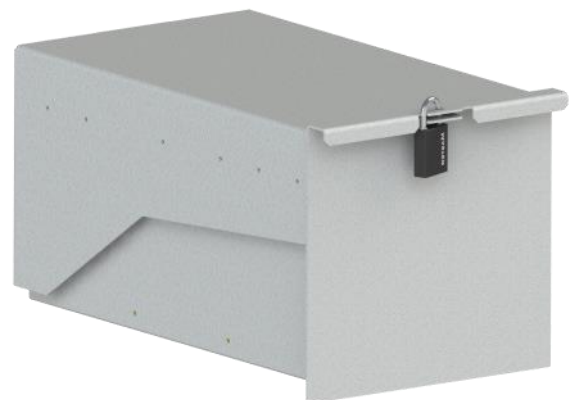

All drawers can be delivered with customer specified inserts, as shown in the pictures below

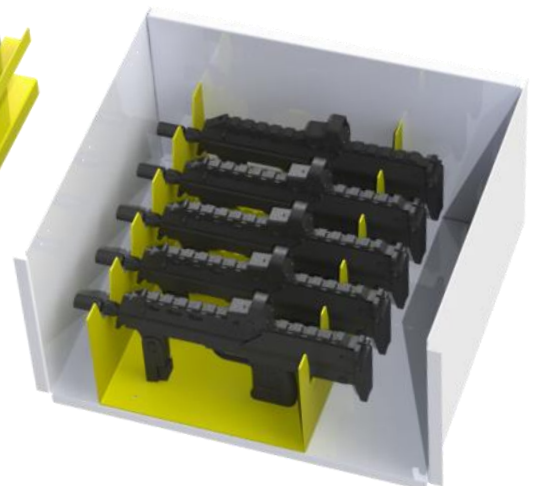
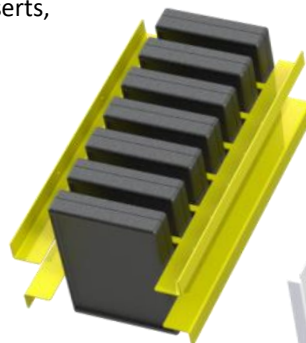
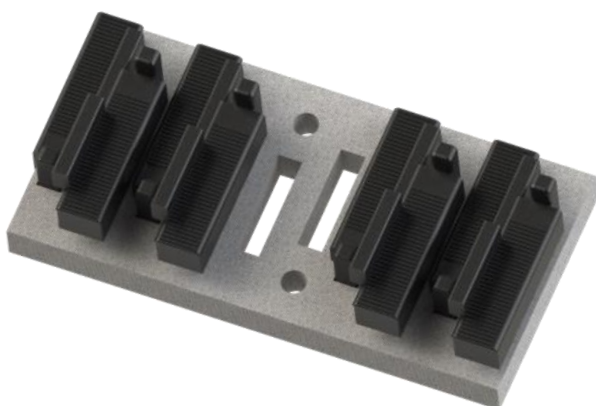



Armory program units installed



Safety cabinets

PART NUMBER: See table

Safety cabinets are used for safe storage of weapons, ammunition and other valuables. The cabinets are prepared for installation of alarm sensors and are approved as burglary protection. They can be equipped with ProRack weapon storage units or with shelves for ammunition and document storage.

Safety cabinet	Dimensions [cm]	Weight [kg]	Part nr.
SSK 290	H190 x B100 x D48	300	810040
SSK 190	H190 x B75 x D48	225	810030
SSK 150	H150 x B55 x D48	160	810020
SSK 70	H73 x B55 x D48	90	810070
SSK 50	H53 x B42 x D35	60	810060
SSK 190 ammunition safe	H190 x B100 x D48	225	820010
SSK 150 ammunition safe	H150 x B55 x D48	160	820020
Electronic code lock	See page 27		359030



The safety cabinets are supplied with a key lock or electronic code lock

SSK 290

PART NUMBER: 810040

The SSK 290 safety cabinet can accommodate up to 18 ProRack One, 16 eBoxes or a combination of the two. The cabinet is prepared for magnetic contacts and a seismic sensor. ProRack storage units are ordered separately.



Electronic code lock for SSK-series

PART NUMBER: 359030

The code lock has options for master code and individual user codes

SSK 190

PART NUMBER: 810030

Safety cabinet for weapon storage. The cabinet accommodates up to 12 ProRack One weapon stands, 12 eBoxes, or a combination of the two, for example 6 of each. The cabinet is prepared for magnetic contacts and seismic sensor. SSK 190 can be equipped with ProRack weapon storage units or with sleeves for ammunition and document storage.



Value and ammunition cabinet SSK 150

PART NUMBER: SSK 150 Ammunition safe with 5 shelves: 820020

SSK 150 weapon safe: 810020



SSK 70

PART NUMBER: 810070



SSK 50

PART NUMBER: 810060



Unloading stations

PART NUMBER: See table

Unloading station made with ballistic material inserts. Robust construction traps the bullet securely. Certified up to 12.7 mm armour piercing bullets.



Model	Part number
Desktop	830010
Wall-mount	830020
Pedestal	830030

The unloading station can be delivered as desktop, wall-mount or ground standing pedestal version.



Accessories

MasterLock Padlock with code

PART NUMBER: 806015

Padlock for ProRack One, pBox, bBox and eBox.



Sensor-bracket kit

PART NUMBER: Bracket kit for SSK 150/190: 810080

Bracket kit for SSK 290: 810081

For retrofitting in SSK safety cabinets



HK416 bracket

PART NUMBER: 803022

This bracket is mounted on ProRack One. It locks the upper cross bolt of the gun and prevents that the weapon can be taken out.



Electronic code lock (SSK series)

PART NUMBER: 359030

For instructions, see: www.raufoss.com/download



Lock clamp with grip knob

PART NUMBER: 207025

Used for ProRack One, pBox, bBox and eBox. Positions the padlock.



WireLock

PART NUMBER: 809085

For locking weapons and other with strong safety-wire. Mount on ProRack panel.





For order or information please contact
Raufoss Engineering AS

Telephone +47 46 89 90 00

E-mail post@raufoss.com

www.raufoss.com

